

LM837

Low Noise Quad Operational Amplifier

General Description

The LM837 is a quad operational amplifier designed for low noise, high speed and wide bandwidth performance. It has a new type of output stage which can drive a 600Ω load, making it ideal for almost all digital audio, graphic equalizer, preamplifiers, and professional audio applications. Its high performance characteristics also make it suitable for instrumentation applications where low noise is the key consideration.

The LM837 is internally compensated for unity gain operation. It is pin compatible with most other standard quad op amps and can therefore be used to upgrade existing systems with little or no change.

Features

- High slew rate 10 V/μs (typ); 8 V/μs (min)
- Wide gain bandwidth product 25 MHz (typ); 15 MHz (min)
- Power bandwidth 200 kHz (typ)
- High output current ±40 mA
- Excellent output drive performance >600Ω
- Low input noise voltage 4.5 nV/√Hz
- Low total harmonic distortion 0.0015%
- Low offset voltage 0.3 mV

Schematic and Connection Diagrams

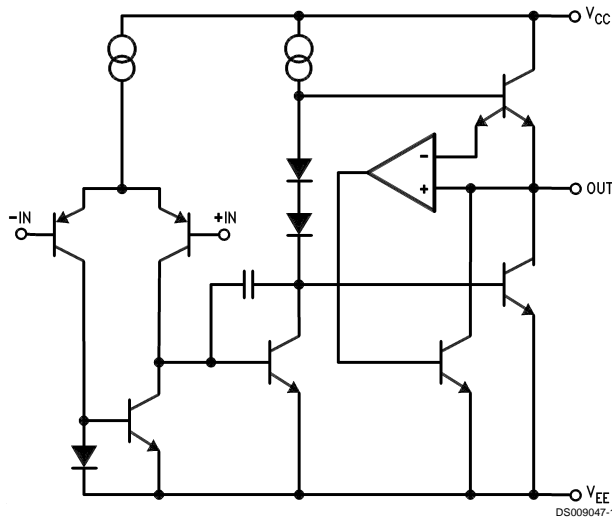

Dual-In-Line Package

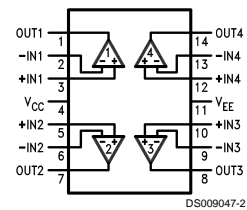

Top View
Order Number LM837M
or LM837N
See NS Package Number
M14A or N14A

Absolute Maximum Ratings (Note 1)

If Military/Aerospace specified devices are required, please contact the National Semiconductor Sales Office/Distributors for availability and specifications.

Supply Voltage, V_{CC}/V_{EE}	$\pm 18V$
Differential Input Voltage, V_{ID} (Note 2)	$\pm 30V$
Common Mode Input Voltage, V_{IC} (Note 2)	$\pm 15V$
Power Dissipation, P_D (Note 3)	1.2W (N) 830 mW (M)
Operating Temperature Range, T_{OPR}	$-40^{\circ}C$ to $+85^{\circ}C$

Storage Temperature Range, T_{STG} $-60^{\circ}C$ to $+150^{\circ}C$

Soldering Information

Dual-In-Line Package	
Soldering (10 seconds)	$260^{\circ}C$
Small Outline Package	
Vapor Phase (60 seconds)	$215^{\circ}C$
Infrared (15 seconds)	$220^{\circ}C$

ESD rating to be determined.

See AN-450 "Surface Mounting Methods and Their Effect on Product Reliability" for other methods of soldering surface mount devices.

DC Electrical Characteristics

$T_A = 25^{\circ}C$, $V_S = \pm 15V$

Symbol	Parameter	Condition	Min	Typ	Max	Units
V_{OS}	Input Offset Voltage	$R_S = 500\Omega$		0.3	5	mV
I_{OS}	Input Offset Current			10	200	nA
I_B	Input Bias Current			500	1000	nA
A_V	Large Signal Voltage Gain	$R_L = 2\text{ k}\Omega$, $V_{OUT} = \pm 10V$	90	110		dB
V_{OM}	Output Voltage Swing	$R_L = 2\text{ k}\Omega$	± 12	± 13.5		V
		$R_L = 600\Omega$	± 10	± 12.5		V
V_{CM}	Common Mode Input Voltage		± 12	± 14.0		V
CMRR	Common Mode Rejection Ratio	$V_{IN} = \pm 12V$	80	100		dB
PSRR	Power Supply Rejection Ratio	$V_S = 15 \sim 5, -15 \sim -5$	80	100		dB
I_S	Power Supply Current	$R_L = \infty$, Four Amps		10	15	mA

AC Electrical Characteristics

$T_A = 25^{\circ}C$, $V_S = \pm 15V$

Symbol	Parameter	Condition	Min	Typ	Max	Units
SR	Slew Rate	$R_L = 600\Omega$	8	10		V/ μs
GBW	Gain Bandwidth Product	$f = 100\text{ kHz}$, $R_L = 600\Omega$	15	25		MHz

Design Electrical Characteristics

$T_A = 25^{\circ}C$, $V_S = \pm 15V$ (Note 4)

Symbol	Parameter	Condition	Min	Typ	Max	Units
PBW	Power Bandwidth	$V_O = 25\text{ V}_{P-P}$, $R_L = 600\Omega$, THD < 1%		200		kHz
e_{n1}	Equivalent Input Noise Voltage	JIS A, $R_S = 100\Omega$		0.5		μV
e_{n2}	Equivalent Input Noise Voltage	$f = 1\text{ kHz}$		4.5		nV/\sqrt{Hz}
i_n	Equivalent Input Noise Current	$f = 1\text{ kHz}$		0.7		pA/\sqrt{Hz}
THD	Total Harmonic Distortion	$A_V = 1$, $V_{OUT} = 3\text{ V}_{rms}$, $f = 20 \sim 20\text{ kHz}$, $R_L = 600\Omega$		0.0015		%
f_U	Zero Cross Frequency	Open Loop		12		MHz
ϕ_m	Phase Margin	Open Loop		45		deg
	Input-Referred Crosstalk	$f = 20 \sim 20\text{ kHz}$		-120		dB
$\Delta V_{OS}/\Delta T$	Average TC of Input Offset Voltage			2		$\mu V/^{\circ}C$

Note 1: Absolute Maximum Ratings indicate limits beyond which damage to the device may occur. Operating Ratings indicate conditions for which the device is functional, but do not guarantee specific performance limits. Electrical Characteristics state DC and AC electrical specifications under particular test conditions which guarantee specific performance limits. This assumes that the device is within the Operating Ratings. Specifications are not guaranteed for parameters where no limit is given, however, the typical value is a good indication of device performance.

Note 2: Unless otherwise specified the absolute maximum input voltage is equal to the power supply voltage.

Design Electrical Characteristics (Continued)

Note 3: For operation at ambient temperatures above 25°C, the device must be derated based on a 150°C maximum junction temperature and a thermal resistance, junction to ambient, as follows: LM837N, 90°C/W; LM837M, 150°C/W.

Note 4: The following parameters are not tested or guaranteed.

Detailed Schematic

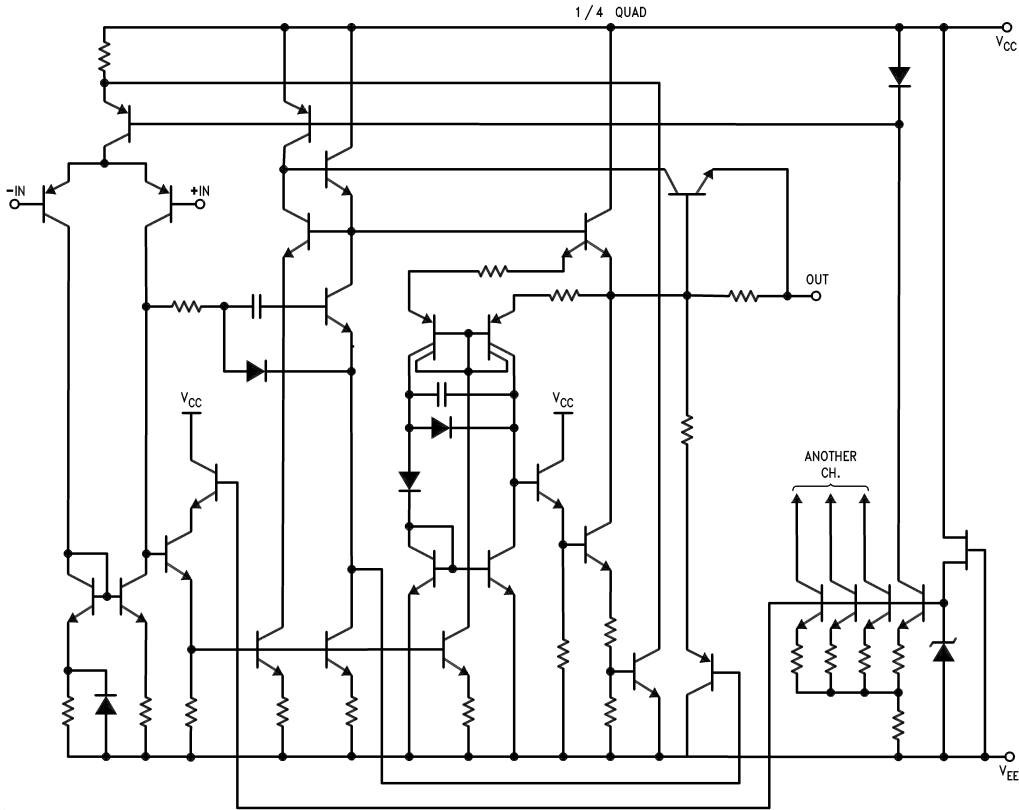

DS009047-3

Typical Performance Characteristics

Maximum Power Dissipation vs Ambient Temperature

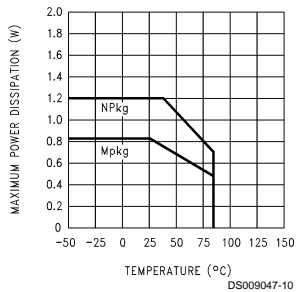

Normalized Input Bias Current vs Supply Voltage

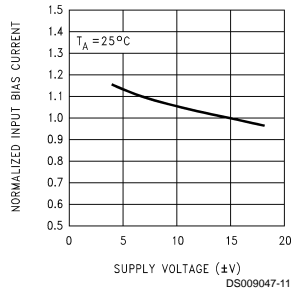

Normalized Input Bias Current vs Ambient Temperature

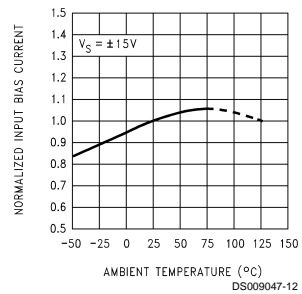

Typical Performance Characteristics (Continued)

Supply Current vs Supply Voltage

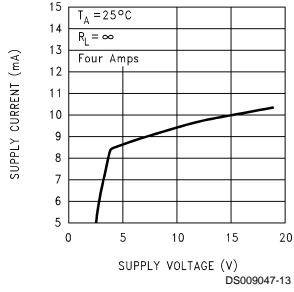

Supply Current vs Ambient Temperature

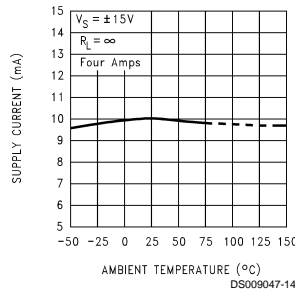

Positive Current Limit

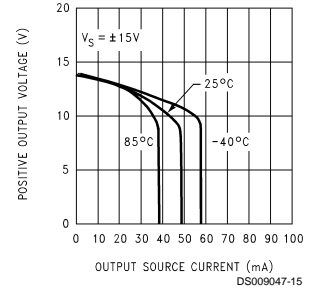

Negative Current Limit

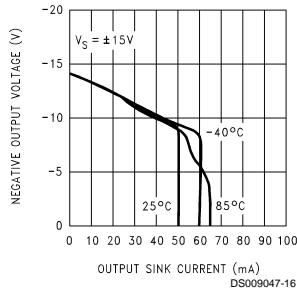

Maximum Output Voltage vs Supply Voltage

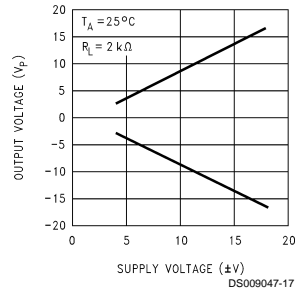

Maximum Output Voltage vs Supply Voltage

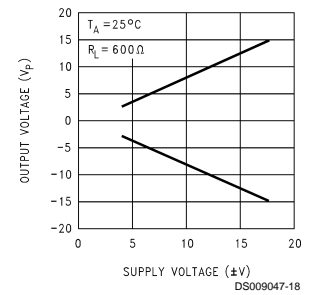

Maximum Output Voltage vs Ambient Temperature

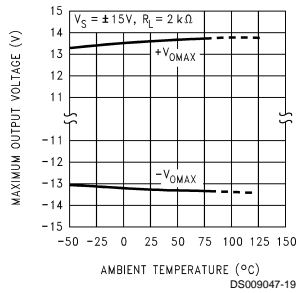

Maximum Output Voltage vs Ambient Temperature

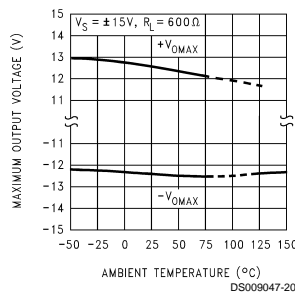

Power Bandwidth

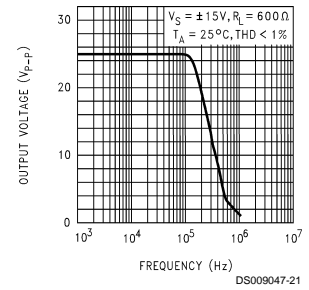

Typical Performance Characteristics (Continued)

Normalized Slew Rate & Gain Bandwidth vs Supply Voltage (f = 100 kHz)

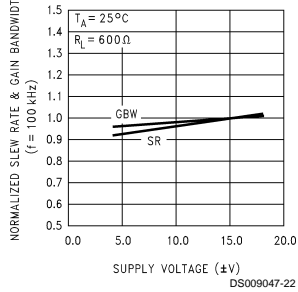

Normalized Slew Rate & Gain Bandwidth (f = 100 kHz) vs Ambient Temperature

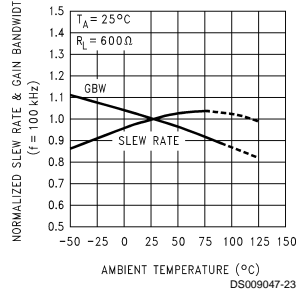

Voltage Gain vs Supply Voltage

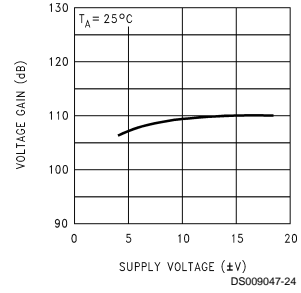

Voltage Gain vs Ambient Temperature

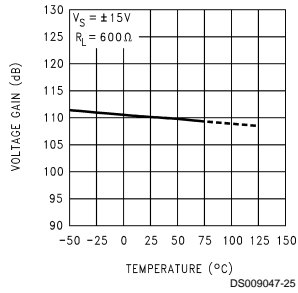

Power Supply Rejection vs Frequency

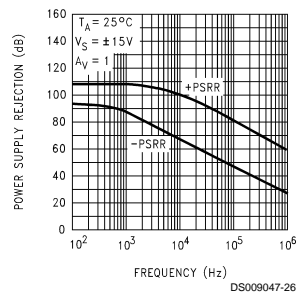

CMRR vs Frequency

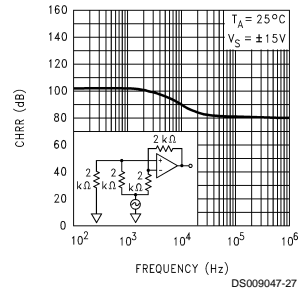

Open Loop Gain & Phase vs Frequency

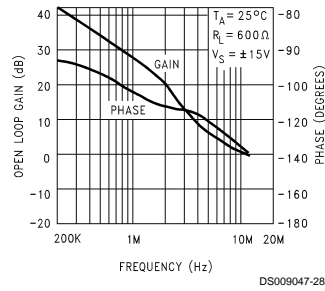

Total Harmonic Distortion vs Frequency

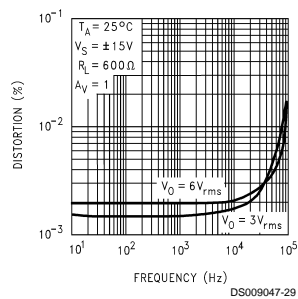

Equivalent Input Noise Voltage vs Frequency

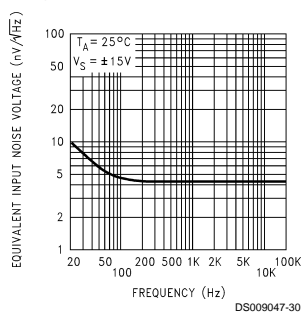

Typical Performance Characteristics (Continued)

Equivalent Input Noise Current vs Frequency

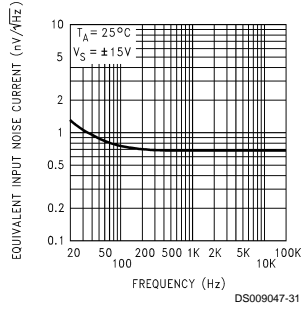

Small Signal, Non-Inverting

$T_A = 25^\circ\text{C}$, $A_V = 1$, $R_L = 600\Omega$, $V_S = \pm 15\text{V}$

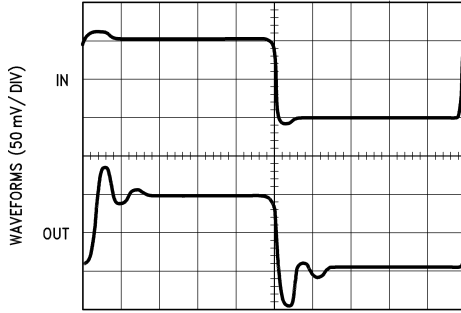

TIME (0.1 μs / DIV)

Current Limit

$T_A = 25^\circ\text{C}$, $V_S = \pm 15\text{V}$, $R_L = 100\Omega$, $A_V = 1$

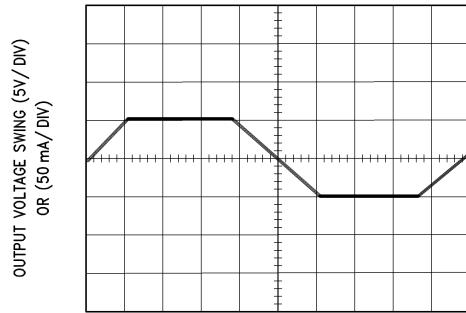

TIME (0.1 ms / DIV)

Large Signal Non-Inverting

$T_A = 25^\circ\text{C}$, $R_L = 600\Omega$, $V_S = \pm 15\text{V}$

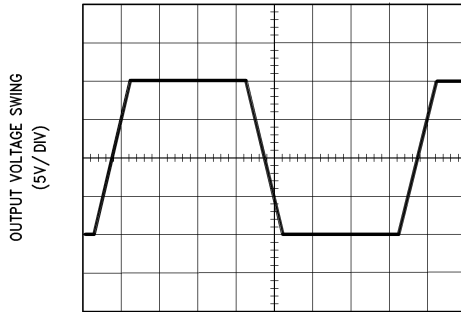

TIME (1 μs / DIV)

Large Signal Inverting

$T_A = 25^\circ\text{C}$, $R_L = 600\Omega$, $V_S = \pm 15\text{V}$

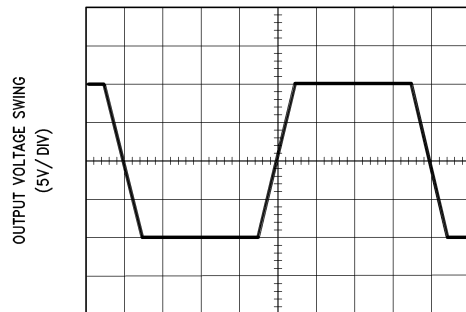

TIME (1 μs / DIV)

Physical Dimensions inches (millimeters) unless otherwise noted

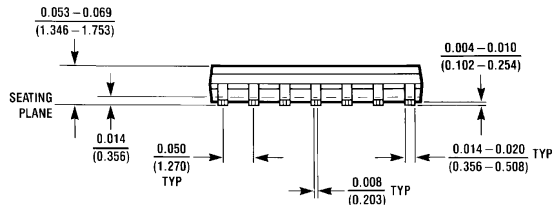
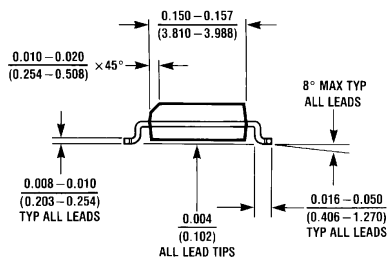
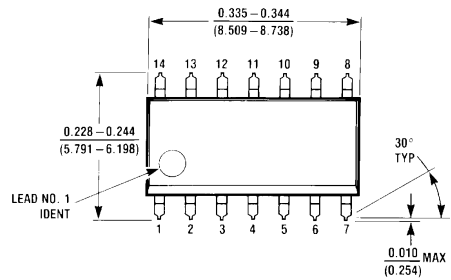

M14A (REV H)

Molded Package (SO)
Order Number LM837M
NS Package Number M14A

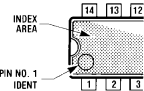
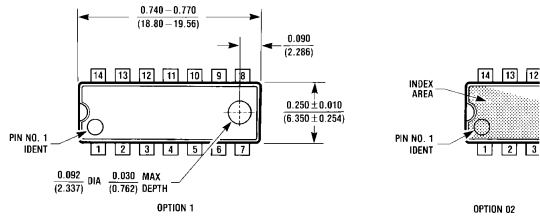

OPTION 02

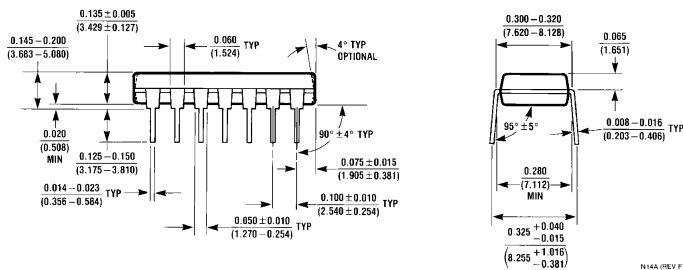

N14A (REV F)

Lit. #107255
Molded Dual-In-Line Package
Order Number LM837N
NS Package Number N14A

Notes

LIFE SUPPORT POLICY

NATIONAL'S PRODUCTS ARE NOT AUTHORIZED FOR USE AS CRITICAL COMPONENTS IN LIFE SUPPORT DEVICES OR SYSTEMS WITHOUT THE EXPRESS WRITTEN APPROVAL OF THE PRESIDENT AND GENERAL COUNSEL OF NATIONAL SEMICONDUCTOR CORPORATION. As used herein:

1. Life support devices or systems are devices or systems which, (a) are intended for surgical implant into the body, or (b) support or sustain life, and whose failure to perform when properly used in accordance with instructions for use provided in the labeling, can be reasonably expected to result in a significant injury to the user.
2. A critical component is any component of a life support device or system whose failure to perform can be reasonably expected to cause the failure of the life support device or system, or to affect its safety or effectiveness.



National Semiconductor Corporation
Americas
Tel: 1-800-272-9959
Fax: 1-800-737-7018
Email: support@nsc.com

www.national.com

National Semiconductor Europe

Fax: +49 (0) 1 80-530 85 86
Email: europe.support@nsc.com
Deutsch Tel: +49 (0) 1 80-530 85 85
English Tel: +49 (0) 1 80-532 78 32
Français Tel: +49 (0) 1 80-532 93 58
Italiano Tel: +49 (0) 1 80-534 16 80

National Semiconductor Asia Pacific Customer Response Group

Tel: 65-2544466
Fax: 65-2504466
Email: sea.support@nsc.com

National Semiconductor Japan Ltd.

Tel: 81-3-5639-7560
Fax: 81-3-5639-7507